

1. FLOW MAY BE IN EITHER DIRECTION
2. VALVE SHAFT WILL MEET OR EXCEED AWWA C504 REQUIREMENTS
3. REFERENCE AWWA C504 FOR FLANGES AND DRILLING (ANSI 125)
4. 29 TURNS TO CLOSE
5. (12) $7/8''$ BOLTS ON EACH FLANGE (NO THREADED HOLES)
6. OPERATED BY 10" HANDWHEEL
7. RATED FOR 150psi WORKING PRESSURE

THIS DWG. AND ALL INFORMATION IS OUR PROPERTY AND SHALL NOT BE USED, COPIED, OR REPRODUCED WITHOUT WRITTEN CONSENT. DESIGN AND INVENTION RIGHTS RESERVED.



M&H VALVE COMPANY

A DIVISION OF McWANE INC.
P.O. BOX 2088
ANNISTON, ALABAMA 36202

DWG. NO.
BD10-W11-M2110-11210

DRAWN: EMW REV.
DATE: 05/18/2021 -

10" AWWA C504 Butterfly Valve - Wafer Style
Class 150
Adapter for F/A12 MSS/ISO Connection
Handwheel Operator - Open Left

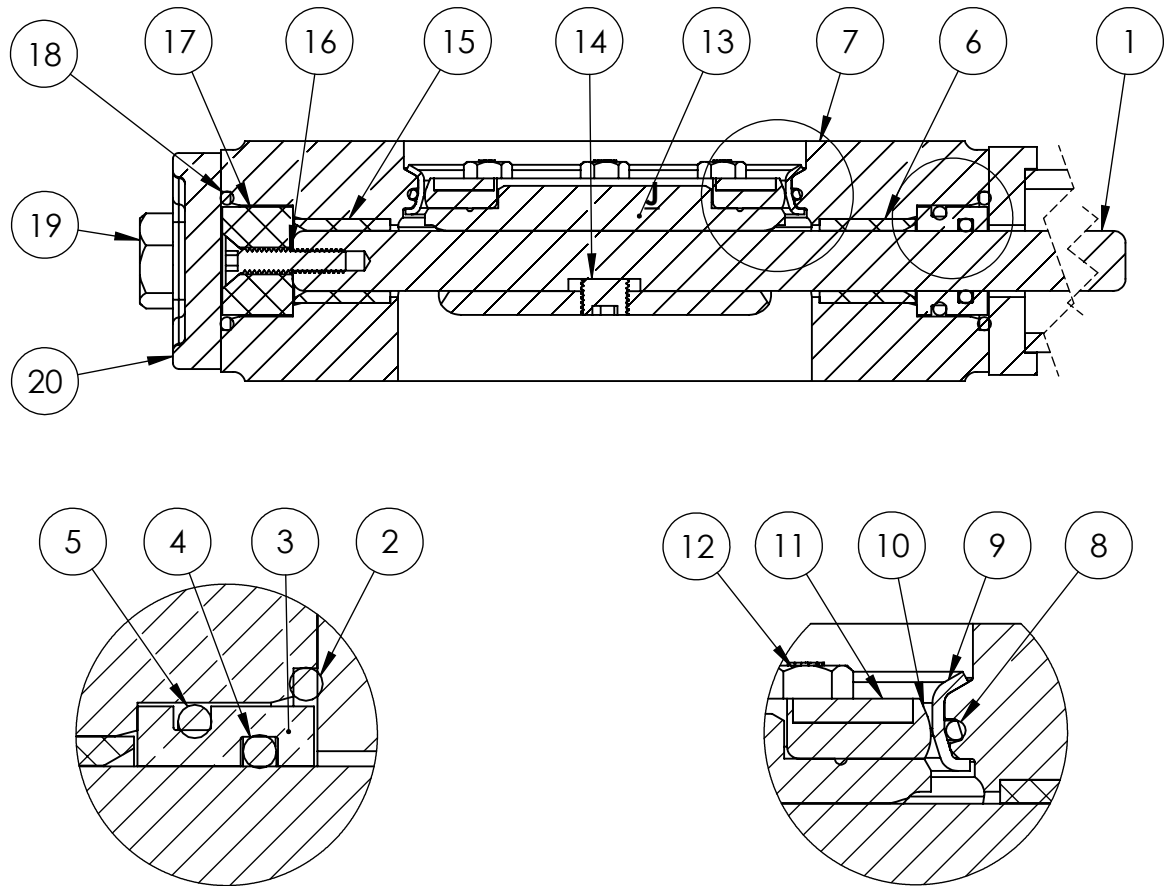

ITEM NO.	DESCRIPTION	MATERIAL
1	OPERATOR SHAFT	304 STAINLESS STEEL, ASTM A-276
2	END O-RING	BUNA-N
3	CARTRIDGE SEAL	ACETAL
4	SHAFT SEAL O-RING (INSIDE)	BUNA-N
5	SHAFT SEAL O-RING (OUTSIDE)	BUNA-N
6	BODY BEARING	NYLATRON GS NYLON
7	VALVE BODY	DUCTILE IRON, ASTM-536 GR 70-50-05
8	BODY O-RING	BUNA-N
9	BODY SEAT RING	304 STAINLESS STEEL, ASTM A-276
10	VANE SEAT RING	EPDM
11	VANE CLAMP RING	304 STAINLESS STEEL, ASTM A-276
12	VANE RING BOLT	18-8 STAINLESS STEEL
13	VANE	DUCTILE IRON ASTM A-536 GR 70-50-05
14	VANE TORQUE PLUG	304 STAINLESS STEEL, ASTM A-276
15	BODY BEARING	NYLATRON GS NYLON
16	SOCKET SCREW	18-8 STAINLESS STEEL
17	THRUST DISK	ACETAL
18	END O-RING	BUNA-N
19	END COVER BOLT	18-8 STAINLESS STEEL
20	END COVER	DUCTILE IRON, ASTM-536 GR 70-50-05

THIS DWG. AND ALL INFORMATION IS OUR PROPERTY AND SHALL NOT BE USED, COPIED, OR REPRODUCED WITHOUT WRITTEN CONSENT. DESIGN AND INVENTION RIGHTS RESERVED.



M&H VALVE COMPANY

A DIVISION OF McWANE INC.
P.O. BOX 2088
ANNISTON, ALABAMA 36202

DWG. NO.

BBAA-W11-B0000-11210

DRAWN: EMW

REV.

DATE: 05/19/2021

-

4" THRU 12" STYLE 4500 CLASS 150
BUTTERFLY VALVE - MATERIAL LIST
WAFER ENDS