

SHAFT INFORMATION

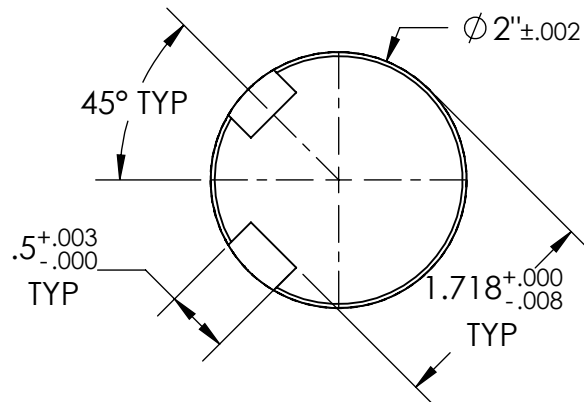

1. FLOW MAY BE IN EITHER DIRECTION
2. VALVE SHAFT WILL MEET OR EXCEED AWWA C504 REQUIREMENTS
3. REFERENCE AWWA C504 FOR FLANGES AND DRILLING (ANSI 125)
4. (16) 1" BOLTS ON EACH FLANGE (NO THREADED HOLES)
5. RATED FOR 150psi WORKING PRESSURE

THIS DWG. AND ALL INFORMATION IS OUR PROPERTY AND SHALL NOT BE USED, COPIED, OR REPRODUCED WITHOUT WRITTEN CONSENT. DESIGN AND INVENTION RIGHTS RESERVED.



M&H VALVE COMPANY

A DIVISION OF McWANE INC.
P.O. BOX 2088
ANNISTON, ALABAMA 36202

DWG. NO.
BD16-W11-B0000-11210

DRAWN: EMW
DATE: 05/18/2021

REV.
-

16" AWWA C504 Butterfly Valve - Wafer Style
Class 150
Adapter for F/A16 MSS/ISO Connection
Bare Stem Operator Shaft

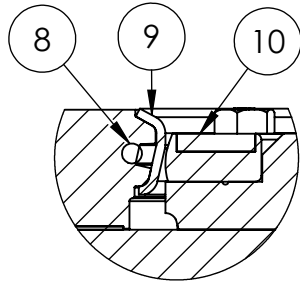
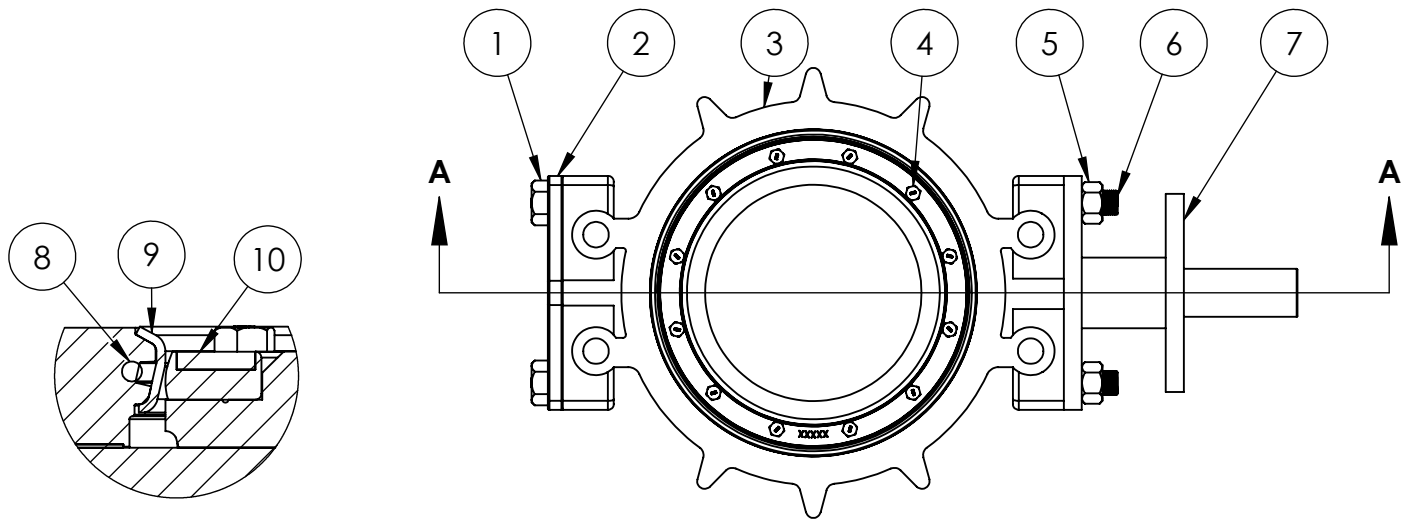

DETAIL B

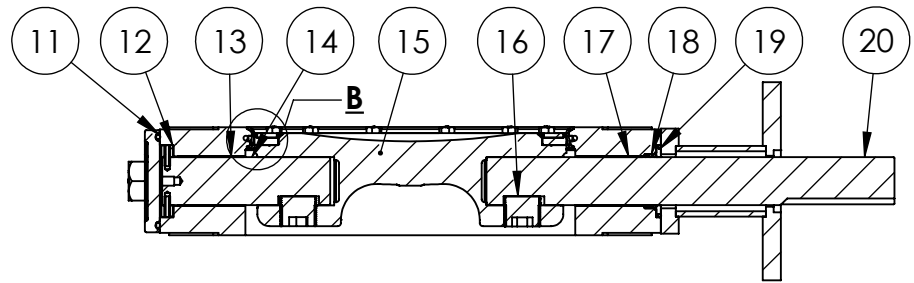

SECTION A-A

#	DESCRIPTION	MATERIAL
1	END PLATE BOLT	18-8 STAINLESS STEEL
2	END PLATE	DUCTILE IRON
3	VALVE BODY	DUCTILE IRON
4	VANE RING BOLT	18-8 STAINLESS STEEL
5	ADAPTER MOUNTING NUT	18-8 STAINLESS STEEL
6	ADAPTER MOUNTING STUD	18-8 STAINLESS STEEL
7	OPERATOR MOUNTING ADAPTER	STEEL
8	BODY O-RING	EPDM
9	BODY SEAT RING	316 STAINLESS STEEL
10	VANE SEAT RING	EPDM W/ STAINLESS STEEL INSERT
11	END PLATE O-RING	EPDM
12	SHAFT THRUST COLLAR	BRONZE
13	LOWER BODY BUSHING	FIBERGLIDE
14	THRUST SHAFT	304 STAINLESS STEEL
15	VANE	DUCTILE IRON
16	SHAFT TORQUE PLUG	18-8 STAINLESS STEEL
17	UPPER BODY BUSHING	FIBERGLIDE
18	JOURNAL PACKING	BUNA-N
19	SEAL RING	BUNA-N
20	OPERATOR SHAFT	304 STAINLESS STEEL

THIS DWG. AND ALL INFORMATION IS OUR PROPERTY AND SHALL NOT BE USED, COPIED, OR REPRODUCED WITHOUT WRITTEN CONSENT. DESIGN AND INVENTION RIGHTS RESERVED.



M&H VALVE COMPANY

A DIVISION OF McWANE INC.
P.O. BOX 2088
ANNISTON, ALABAMA 36202

DWG. NO.
BBBB-W11-B0000-11210
DRAWN: EMW
DATE: 05/18/2021
REV.
-

14" - 20" AWWA C504 BUTTERFLY VALVE
WAFFER STYLE - CL150 BODY SUB-ASM
MATERIAL LIST FA16 MOUNTING ADAPTER