

1. FLOW MAY BE IN EITHER DIRECTION
2. VALVE SHAFT WILL MEET OR EXCEED AWWA C504 REQUIREMENTS
3. REFERENCE C504 FOR FLANGES (250B) AND DRILLING (ANSI 250)
4. ASME B16.1 CL250 FLANGES W/ RAISED FACE & STANDARD DRILLING
5. 48 TURNS TO CLOSE
6. (24) 1 1/4" BOLTS ON EACH FLANGE (8 THREADED HOLES. 1 1/4"-7 UNC, THREADED THRU)
7. OPERATED BY 18" HANDWHEEL
8. RATED FOR 250psi WORKING PRESSURE

THIS DWG. AND ALL INFORMATION IS OUR PROPERTY AND SHALL NOT BE USED, COPIED, OR REPRODUCED WITHOUT WRITTEN CONSENT. DESIGN AND INVENTION RIGHTS RESERVED.



M&H VALVE COMPANY

A DIVISION OF McWANE INC.
P.O. BOX 2088
ANNISTON, ALABAMA 36202

DWG. NO.

BD18-F43-M2110-11210

DRAWN: EMW

REV.

DATE: 04/30/2021

-

18" AWWA C504 BUTTERFLY VALVE
FLANGED ENDS - RATED CL250
HANDWHEEL OPERATOR - OPEN LEFT
FA16 MSS/ISO ADAPTER

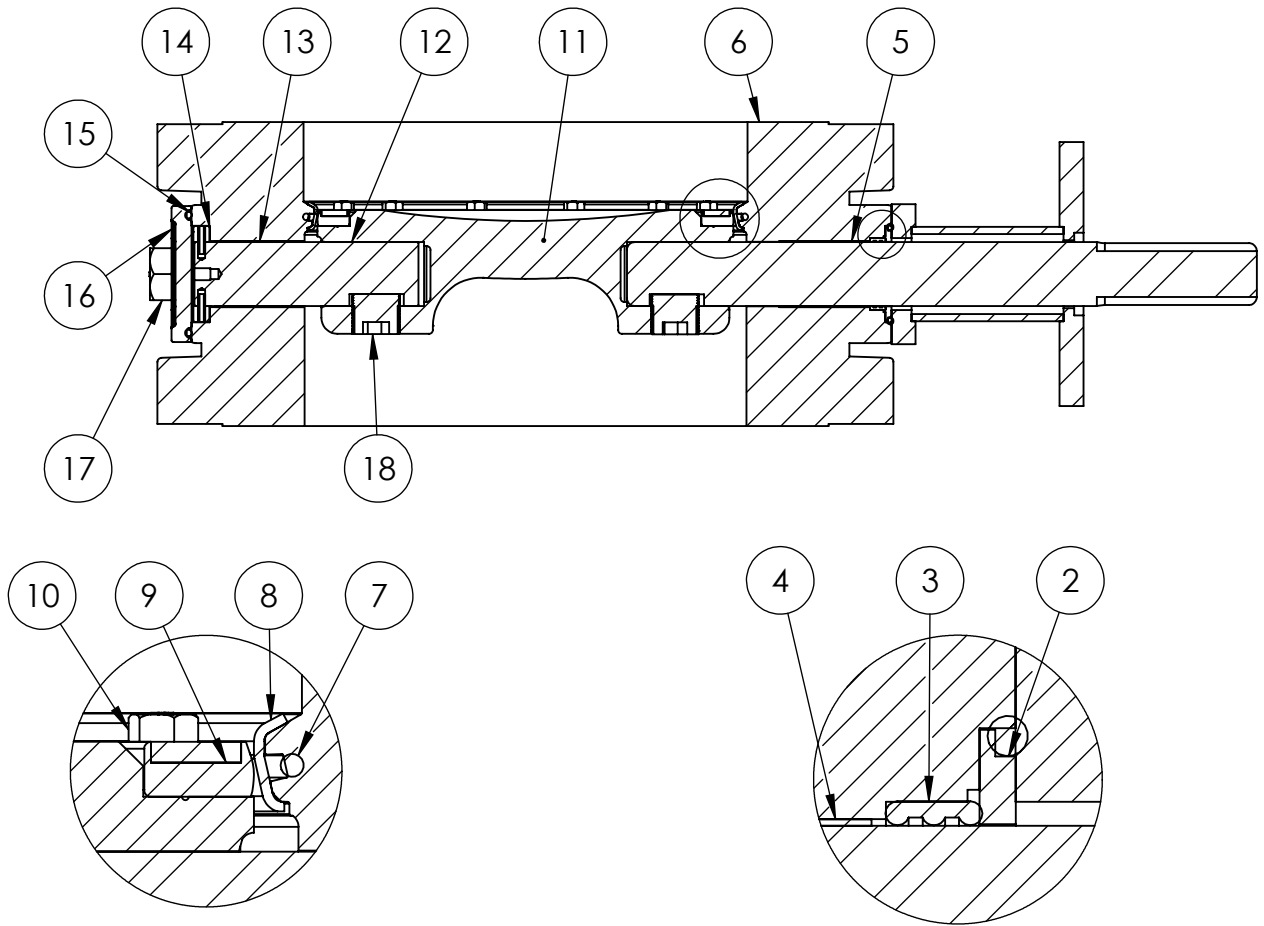

ITEM NO.	DESCRIPTION	MATERIAL
1	OPERATOR SHAFT	630 STAINLESS STEEL, ASTM A-564
2	VALVE SEAL RING	EPDM
3	JOURNAL PACKING	EPDM
4	UPPER BODY BUSHING	FIBERGLIDE
5	VALVE BODY	DUCTILE IRON, ASTM A-536, GR 70-50-05
6	BODY O-RING	EPDM
7	BODY SEAT RING	316 STAINLESS STEEL, ASTM A-276
8	VANE CLAMP RING	304 STAINLESS STEEL, ASTM A-276
9	VANE BOLT	18-8 STAINLESS STEEL
10	VANE	DUCTILE IRON, ASTM A-536, GR 70-50-05
11	THRUST SHAFT	630 STAINLESS STEEL, ASTM A -564
12	LOWER BODY BUSHING	FIBERGLIDE
13	THRUST COLLAR	BRONZE
14	END COVER O-RING	EPDM
15	END COVER	DUCTILE IRON, ASTM A-536, GR 70-50-05
16	END COVER BOLTS	18-8 STAINLESS STEEL
17	SHAFT TORQUE PLUG	18-8 STAINLESS STEEL

THIS DWG. AND ALL INFORMATION IS OUR PROPERTY AND SHALL NOT BE USED, COPIED, OR REPRODUCED WITHOUT WRITTEN CONSENT. DESIGN AND INVENTION RIGHTS RESERVED.



M&H VALVE COMPANY

A DIVISION OF McWANE INC.
P.O. BOX 2088
ANNISTON, ALABAMA 36202

DWG. NO.
BBBB-F43-B0000-1110
DRAWN: EMW
DATE: 05/21/2021
REV. -

14" - 24" AWWA C504 BUTTERFLY VALVE
FLANGED ENDS - RATED CL250
BODY SUB-ASM MATERIAL LIST