

SHAFT DIMENSIONS & TOLERANCES

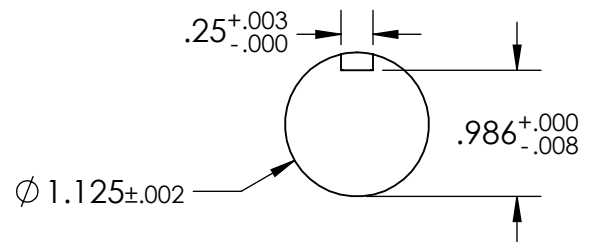

1. FLOW MAY BE IN EITHER DIRECTION
2. VALVE SHAFT WILL MEET OR EXCEED AWWA C504 REQUIREMENTS
3. REFERENCE AWWA C504 FOR FLANGES AND DRILLING (ANSI 125)
4. (8) 3/4" BOLTS ON EACH FLANGE (NO THREADED HOLES)
5. RATED FOR 150PSI WORKING PRESSURE

THIS DWG. AND ALL INFORMATION IS OUR PROPERTY AND SHALL NOT BE USED, COPIED, OR REPRODUCED WITHOUT WRITTEN CONSENT. DESIGN AND INVENTION RIGHTS RESERVED.



M&H VALVE COMPANY

A DIVISION OF McWANE INC.
P.O. BOX 2088
ANNISTON, ALABAMA 36202

DRAWN: CTJ
DATE: 10/14/2020
DWG. NO.
BD08-F11-B0000-11110

8" AWWA C504 BUTTERFLY VALVE
FLANGED ENDS - CL150
BARESTEM
FA12 OPERATOR FLANGE

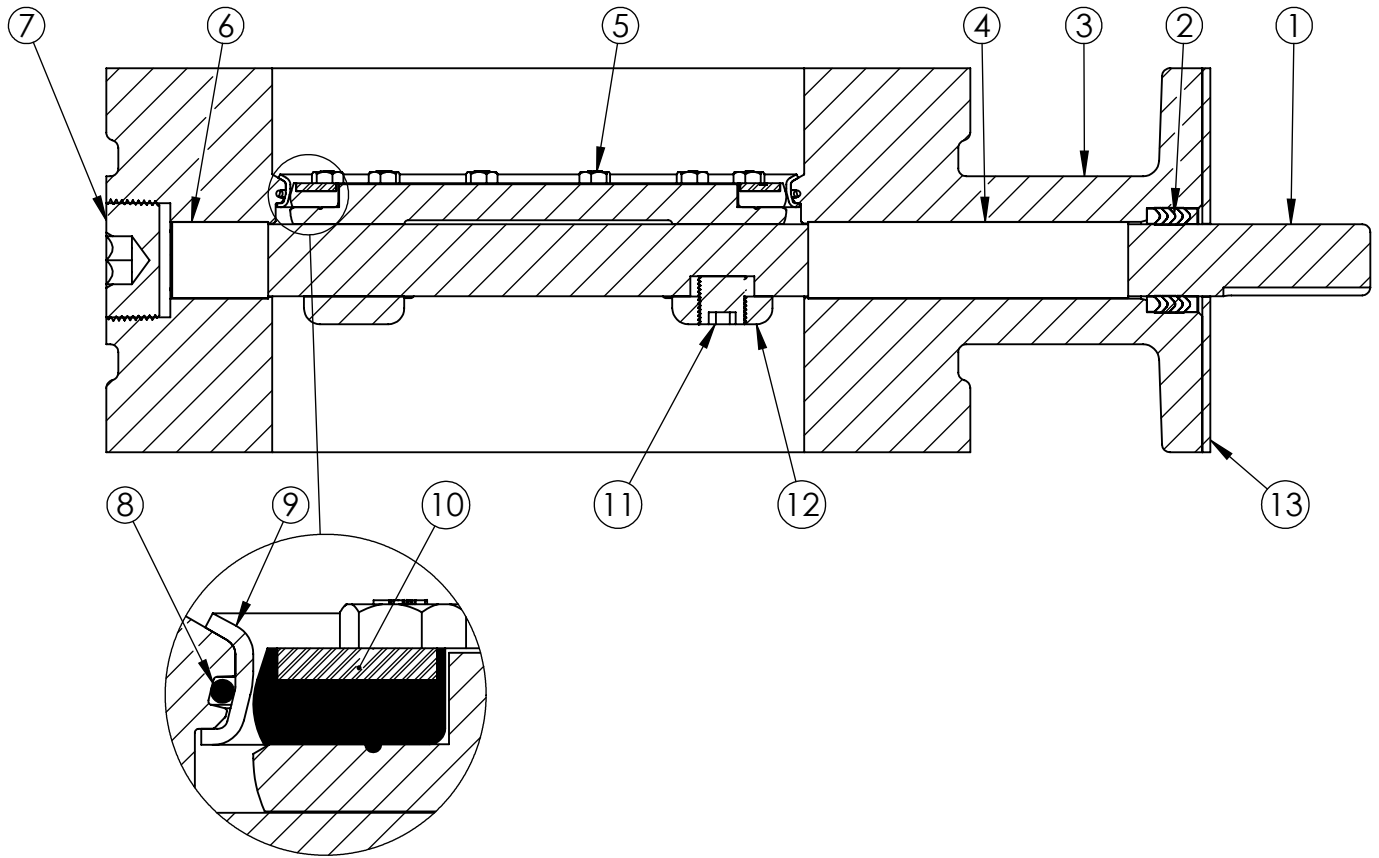

NOTES:

1. (*) SEAL PLATE PROVIDED WITH ALL BARESTEM VALVES,
AND USED WITH ALL PURCHASED OPERATORS

ITEM	DESCRIPTION	MATERIAL
1	OPERATOR SHAFT	304 STAINLESS STEEL, ASTM A-276
2	V-RING PACKING	EPDM & BUNA-N
3	BUTTERFLY VALVE BODY	DUCTILE IRON, ASTM A-536
4	UPPER JOURNAL BEARING	NYLATRON
5	VANE RING HEXHEAD CAP SCREWS	18-8 STAINLESS STEEL
6	LOWER JOURNAL BEARING	NYLATRON
7	BODY END PLUG	STEEL
8	BODY O-RING	EPDM
9	BODY SEAT RING	316 STAINLESS STEEL
10	VANE SEAT RING	EPDM W/ STAINLESS STEEL INSERT
11	VANE SHAFT TORGE PLUG	18-8 STAINLESS STEEL
12	VANE	DUCTILE IRON, ASTM A-536
13	SEAL PLATE *	STEEL

THIS DWG. AND ALL INFORMATION IS OUR PROPERTY AND SHALL NOT BE USED, COPIED, OR REPRODUCED WITHOUT WRITTEN CONSENT. DESIGN AND INVENTION RIGHTS RESERVED.



M&H VALVE COMPANY

A DIVISION OF McWANE INC.
P.O. BOX 2088
ANNISTON, ALABAMA 36202

DRAWN: CTJ
DATE: 10/14/2020
DWG. NO.
BB08-F11-B0000-11110

8" AWWA C504 BUTTERFLY VALVE
FLANGED ENDS - CL150
BODY SUB-ASM MATERIAL LIST
FA12 OPERATOR FLANGE